



American Opto Plus LED Corp.

L234LYC-TR

3.8 x 1.2 x 0.6 Yellow SMD, Tape and Reel

PACKAGE OUTLINES

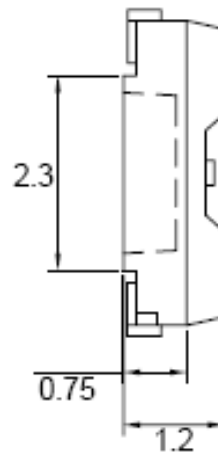
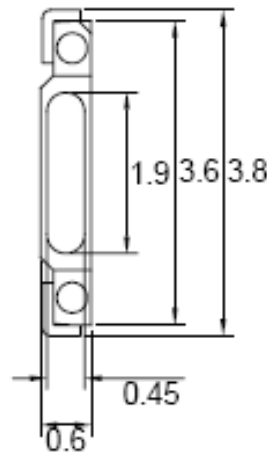
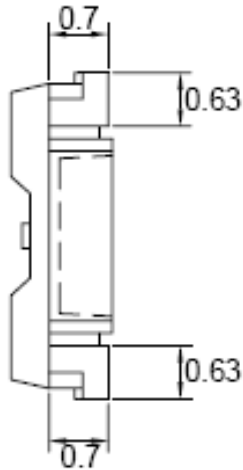

Cathode



Anode

Polarity

RECOMMEND PAD LAYOUT

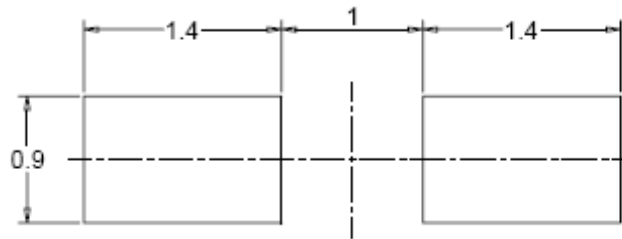

NOTES:

1. All dimensions are in millimeters tolerance is ± 0.2 mm unless otherwise noted; Angle ± 0.5 . Unit=mm.

Part Number	Material	Lens Color	
		Emitted	Lens
L234LYC-TR	AlGaInP	Yellow	Water Clear



American Opto Plus LED Corp.

L234LYC-TR

3.8 x 1.2 x 0.6 Yellow SMD, Tape and Reel

ABSOLUTE MAXIMUM RATINGS

(Ta=25°C)

Parameter	Symbol	Ratings	Unit
Reverse Voltage	Vr	5	V
Forward Current	If	50	mA
Peak Forward Current (Duty 1/10@10ms)	Ifp	90	mA
Power Dissipation	Pd	120	mW
Reverse Current @5V	Ir	10	μA
Electrostatic Discharge	ESD	2000	V
Operating temperature range	Topr	-40~+85	°C
Storage temperature range	Tstg	-40~+100	°C
Soldering temperature range	Tsol	Reflow soldering: 260°C for 10 sec. Hand soldering: 350°C for 3 sec.	

OPTICAL-ELECTRICAL CHARACTERISTICS

(Ta=25°C)

Parameter	Symbol	Test Condition	Min	Typ	Max	Unit
Luminous Intensity	Iv	If=20mA	200	320	--	mcd
Dominant Wavelength	λD		--	595	--	nm
Spectral Radiation Bandwidth	Δλ		--	15	--	nm
Forward Voltage	Vf		1.7	--	2.6	V
Viewing Angle	2θ ½		--	110	--	Deg
Reverse Current	Ir	VR=5V	--	--	10	μA

- Note: 1. Tolerance of luminous intensity: ±15%
2. Tolerance of dominant wavelength: ±1nm
3. Tolerance of forward voltage: ±0.1V



American Opto Plus LED Corp.

L234LYC-TR

3.8 x 1.2 x 0.6 Yellow SMD, Tape and Reel

BIN RANGE OF LUMINOUS INTENSITY

Bin	Min	Max	Unit	Condition
S	200	320	mcd	$I_F=20\text{mA}$
T	320	500		
U	500	800		

BIN RANGE OF DOMINANT WAVELENGTH

Bin Code	Min	Max	Unit	Condition
17-2	590	591	nm	$I_F=20\text{mA}$
17-3	591	592		
18	592	595		
19	595	598		



American Opto Plus LED Corp.

L234LYC-TR

3.8 x 1.2 x 0.6 Yellow SMD, Tape and Reel

TYPICAL ELECTRO-OPTICAL CHARACTERISTIC CURVES

Fig.1 Forward current vs. Forward Voltage

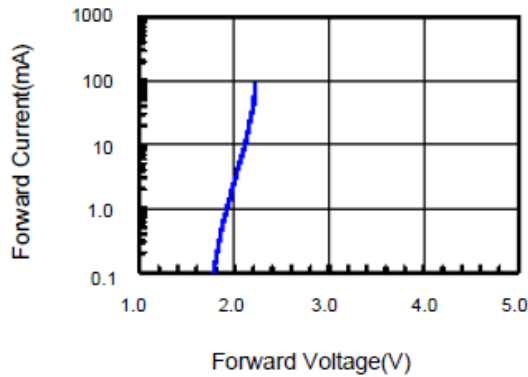

Fig.2 Relative Intensity vs. Forward Current

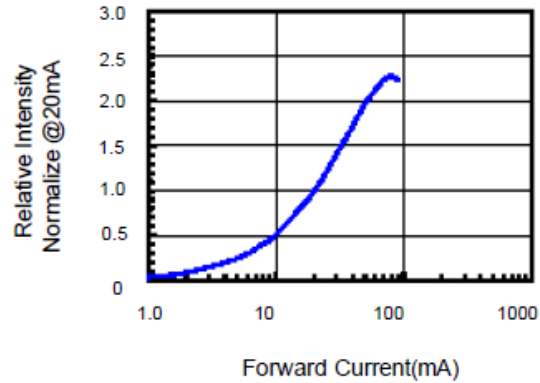

Fig.3 Forward Voltage vs. Temperature

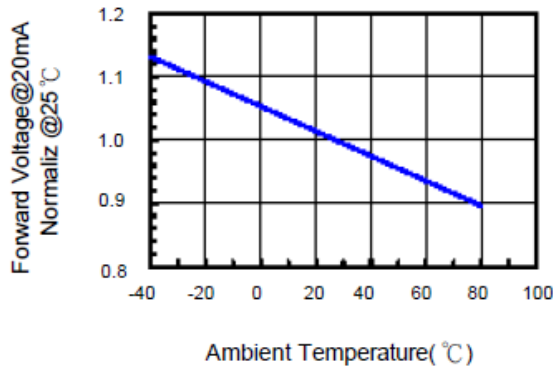

Fig.4 Relative Intensity vs. Temperature

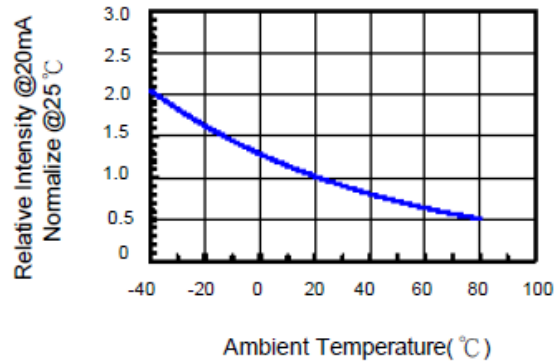

Fig.5 Relative Intensity vs. Wavelength

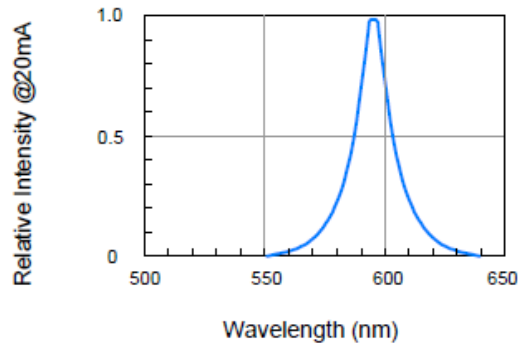
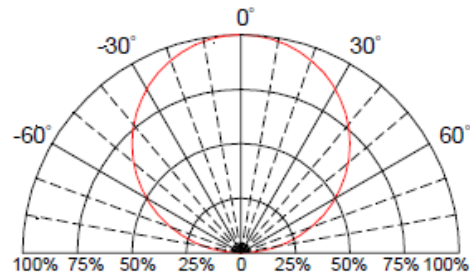

Fig.6 Directive Radiation





American Opto Plus LED Corp.

L234LYC-TR

3.8 x 1.2 x 0.6 Yellow SMD, Tape and Reel

CARRIER TAPE DIMENSION

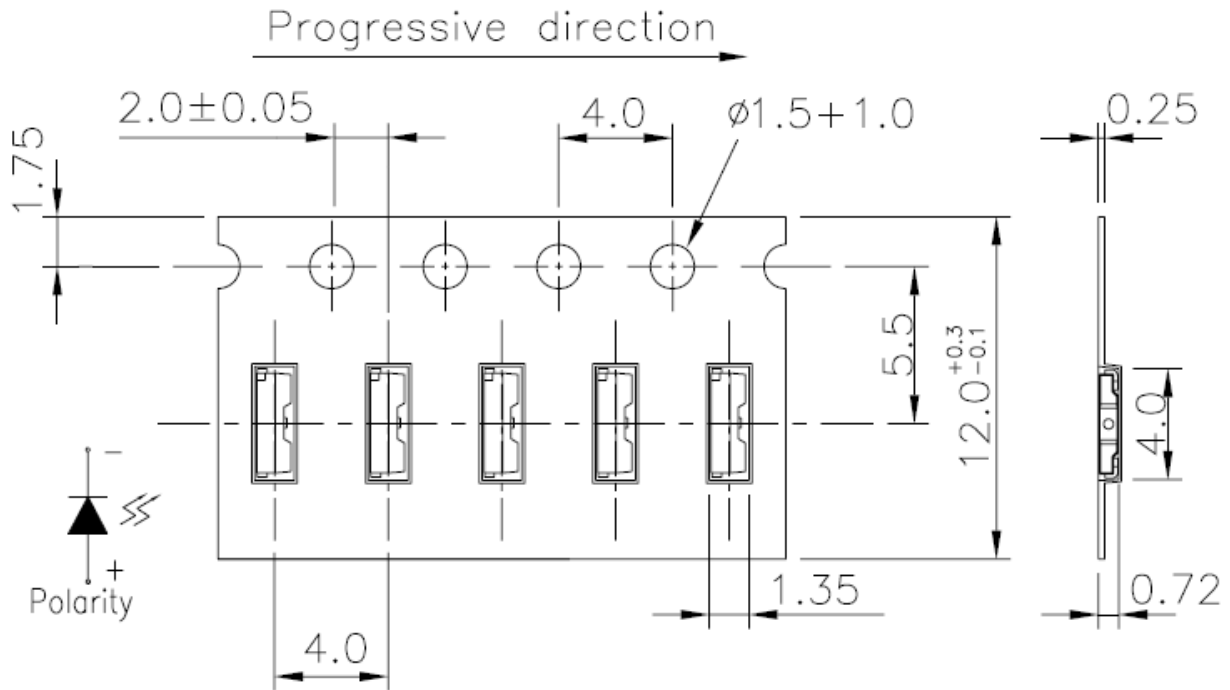

Note: The tolerances unless mentioned are ± 0.1 mm, Angle ± 0.5 ; Unit=mm

REEL DIMENSIONS

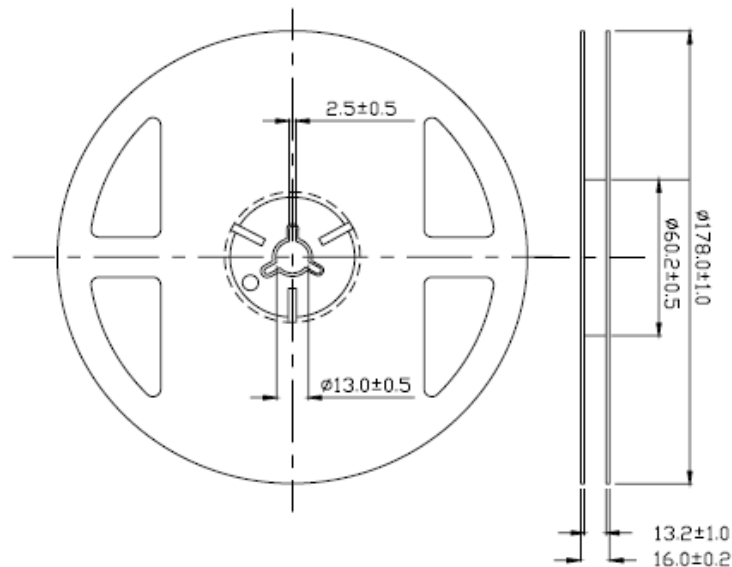

Notes:

1. 3000 pieces per reel
2. Tolerance unless mentioned is ± 0.1 mm; Unit=mm

Version 1.6 Date:5-15-2017 Specifications are subject to change without notice.

American Opto Plus LED Corp. 1206 E. Lexington Ave. , Pomona CA 91766 Tel: 909-465-0080 Fax: 909-465-0130 www.aopled.com



American Opto Plus LED Corp.

L234LYC-TR

3.8 x 1.2 x 0.6 Yellow SMD, Tape and Reel

PRECAUTIONS FOR USE

1. Hand solder
Basic spec is $\leq 320^{\circ}\text{C}$ 3 sec one time only.
2. Wave solder

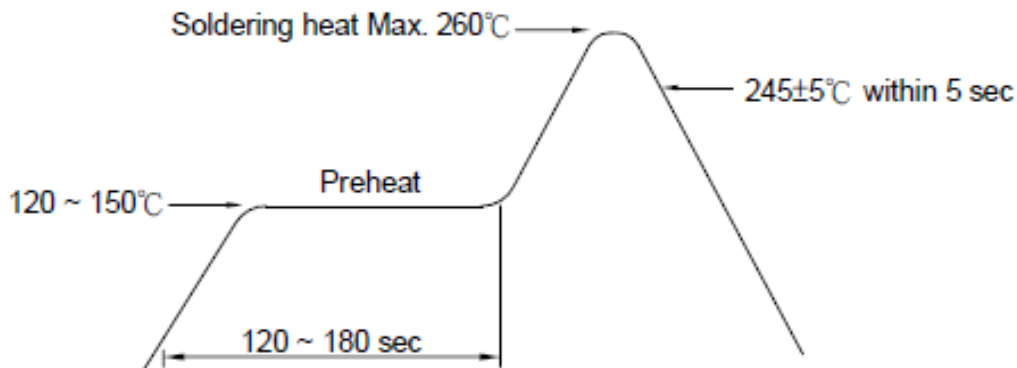

3. PB-Free reflow solder

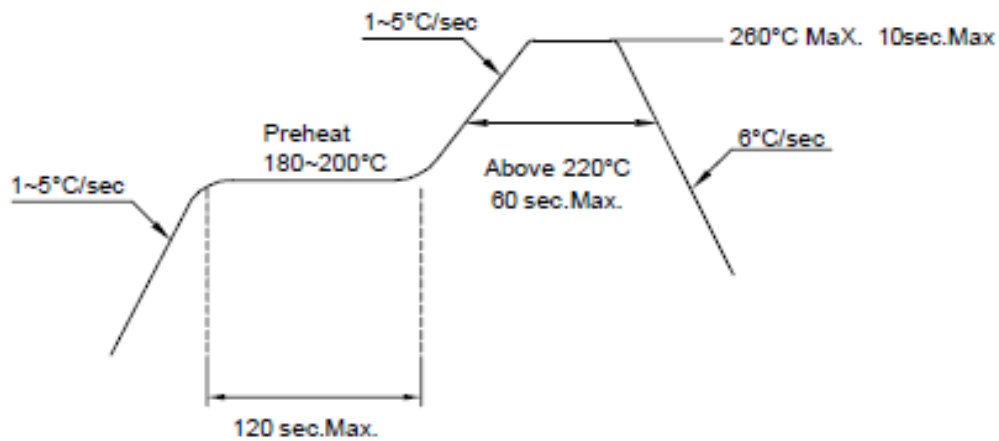

Notes:

1. Reflow soldering should not be done more than two times.
2. When soldering, do not put stress on the LEDs during heating.
3. After soldering, do not warp the circuit board.



American Opto Plus LED Corp.

L234LYC-TR

3.8 x 1.2 x 0.6 Yellow SMD, Tape and Reel

PRECAUTIONS FOR USE:

Storage Time:

1. The operation of temperatures and RH are: 5°C~35°C, RH60%.
2. Once the package is opened, the products should be used within a week. Otherwise, they should be kept in a damp proof box with desiccating agent. Considering the tape life, we suggest our customers to use our products within a year (from production date).
3. If opened more than one week in an atmosphere 5°C~35°C, RH60%, they should be treated at 60°C±5°C for 15hrs.

Drive Method:

LED is a current operated device, and therefore, require some kind of current limiting incorporated into the driver circuit. This current limiting typically takes the form of a current limiting resistor placed in a series with the LED.

Consider worst case voltage variations that could occur across the current limiting resistor. The forward current should not be allowed to change by more than 40% of its desired value.

Circuit model A

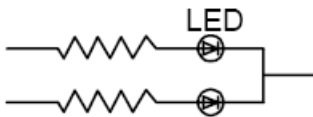

Circuit model B

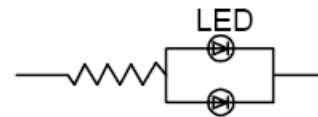

(A) Recommended circuit.

(B) The difference of brightness between LED could be found due to the VF-IF characteristics of LED.

Cleaning:

Use alcohol-based cleaning solvents such as isopropyl alcohol to clean the LED.

ESD(Electrostatic Discharge):

Static Electricity or power surge will damage the LED. Use of a conductive wrist band or anti-electrostatic glove is recommended when handling these LEDs. All devices and machinery must be properly grounded.



American Opto Plus LED Corp.

L234LYC-TR

3.8 x 1.2 x 0.6 Yellow SMD, Tape and Reel

RELIABILITY TEST

1. Test items and results

Classification	Test Item	Test Condition	Sample Size
Endurance Test	Operating Life Test	1.Ta=Under Room Temperature As Per Data Sheet Maximum Rating. 2.If=20mA 3.t=1000 hrs	22
	High Temperature Storage Test	1.Ta=105°C±5°C 2.t=500 hrs	22
	Low Temperature Storage Test	1.Ta=-40°C±5°C 2.t=1000 hrs	22
	High Temperature High Humidity Storage Test	1.IR-Reflow In-Board, 2 Times 2.Ta=85°C±5°C 3.RH=90%~95% 4.t=500hrs±2hrs	22
Environmental Test	Thermal Shock Test	1.IR-Reflow In-Board, 2 times 2.Ta=105°C±5°C & -40°C±5°C (30min) (30min) 3.total 100 cycles	22
	Reflow Soldering Test	1.T.Sol=260°C±5°C 2.Dwell Time= 10Max.	22
	Temperature Cycling	1.105°C ~ 25°C ~ -40°C 30mins 15mins 30mins 2.100 Cycles	22

2. Criteria for judging the damage

Item	Symbol	Test Conditions	Criteria for Judgement	
			Min.	Max.
Forward Voltage	Vf	If=20mA	-	U.S.L x1.2
Reverse Current	Ir	Vr=5V	-	U.S.L x2.0
Luminous Intensity	Iv	If=20mA	L.S.L x 0.5	-

Note:

1. U.S.L.: Upper Standard Level
2. L.S.L.: Lower Standard Level

Version 1.6 Date:5-15-2017 Specifications are subject to change without notice.

American Opto Plus LED Corp. 1206 E. Lexington Ave. , Pomona CA 91766 Tel: 909-465-0080 Fax: 909-465-0130 www.aopled.com