



◆ 用途

主要用于调光、调温等调压电路，微波炉、洗衣机、电风扇、饮水机、夜明灯等家电的控制电路及用于交流相控、斩波器、逆变器、变频器和固态继电器等电路中

◆ 特征

采用先进的玻璃钝化工艺，较低的通态压降，高的可靠性、稳定性

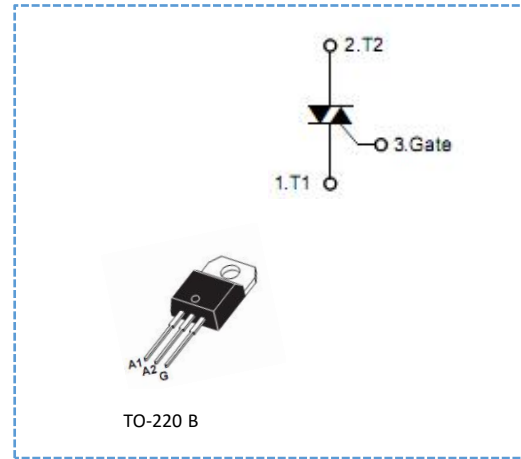

◆ 极限值

名称	符号	规范值	单位	测试条件
断态重复峰值电压	$V_{DRM}/V_{RRM}$	600/800	V	
通态均方根电流	$I_{T(RMS)}$	16	A	$T_c=105^{\circ}C$
浪涌电流	$I_{TSM}$	168	A	正弦波 60Hz $t=16.7ms$
	$I^2t$	144	$A^2s$	$t_p=10ms$
通态电流临界上升率	$di/dt$	50	$A/\mu s$	$I_G=2I_{GT}$ $t_r \leq 100ns$ $F=120Hz$
门极峰值电流	$I_{GM}$	4	A	$T_j=125^{\circ}C$ $t_p=20\mu s$
门极峰值电压	$V_{GM}$	5	V	$T_j=125^{\circ}C$
门极峰值功率	$P_{GM}$	5	W	$T_j=125^{\circ}C$
平均门极功率	$P_{G(AV)}$	1	W	$T_j=125^{\circ}C$
结温	$T_j$	125	$^{\circ}C$	
贮存温度	$T_{stg}$	-40~150	$^{\circ}C$	

◆ 电特性

三象限产品电特性

名称	符号	测试条件	象限		SW	CW	BW	单位
重复峰值阻断电流	$I_{DRM}/I_{RRM}$	$V_{DRM}=V_{RRM}$ $T_j=25^{\circ}C$	MAX		5			$\mu A$
		$V_{DRM}=V_{RRM}$ $T_j=125^{\circ}C$	MAX		2			mA
通态电压	$V_{TM}$	$I_T=22.5A$ $t_p=380\mu s$	MAX		1.55			V
维持电流	$I_H$	$I_{GT}=500mA$	MAX	15	35	50	mA	
擎住电流	$I_L$	$I_G=1.2I_{GT}$	I - III	MAX	25	50	70	mA
			II		30	60	80	mA
门极触发电流	$I_{GT}$	$V_D=12V$ $R_L=30\Omega$	I - II - III	MAX	10	35	50	mA
门极触发电压	$V_{GT}$				1.3			V
门极不触发电压	$V_{GD}$	$V_D=V_{DRM}$ $R_L=3.3K\Omega$ $T_j=125^{\circ}C$	MIN		0.2			V
断态电压临界上升率	$dV/dt$	$V_{DM}=67\%V_{DRM}$ Gate open $T_j=125^{\circ}C$	MIN	40	500	1000	$V/\mu s$	

换向电压临界上升率	$(dV/dt)_c$	$V_{DM}=400V$ $T_j=125^\circ C$ $(dI/dt)_c=1.8A/ms$ Gate open	MIN	10	$V/\mu s$
-----------	-------------	--	-----	----	-----------

### 四象限产品电特性

名称	符号	测试条件	象限		C	B	单位
断态重复峰值电流	$I_{DRM}$	$V_{DRM}=V_{RRM}$ $T_j=25^\circ C$		MAX	5		$\mu A$
		$V_{DRM}=V_{RRM}$ $T_j=125^\circ C$		MAX	2		mA
通态电压	$V_{TM}$	$I_T=22.5A$ $t_p=380\mu s$		MAX	1.55		V
维持电流	$I_H$	$I_{GT}=500mA$		MAX	25	50	mA
擎住电流	$I_L$	$I_G=1.2I_{GT}$	I - III-IV	MAX	40	50	mA
			II		80	100	mA
门极触发电流	$I_{GT}$	$V_D=12V$ $R_L=30\Omega$	I - II - III	MAX	25	50	mA
			IV		50	100	
门极触发电压	$V_{GT}$		I - II - III-IV		1.3		V
门极不触发电压	$V_{GD}$	$V_D=V_{DRM}$ $R_L=3.3K\Omega$ $T_j=125^\circ C$		MIN	0.2		V
断态电压临界上升率	$dV/dt$	$V_{DM}=67\%V_{DRM}$ Gate open $T_j=125^\circ C$		MIN	200	400	$V/\mu s$
换向电压临界上升率	$(dV/dt)_c$	$(dI/dt)_c=5.3A/ms$ Gate open $T_j=125^\circ C$		MIN	5	10	$V/\mu s$

### ◆ 产品包装

封装形式	数量	包装材质
TO-220A/M/F	50/条、1000/盒、5000/箱	盒/箱
TO-263		
发货方式	快 递	

### ◆ 产品保管条件

温度	10-30 $^\circ C$
湿度	<60%
放置期限	一年
保管状态	仓储

### ◆ 特性数据

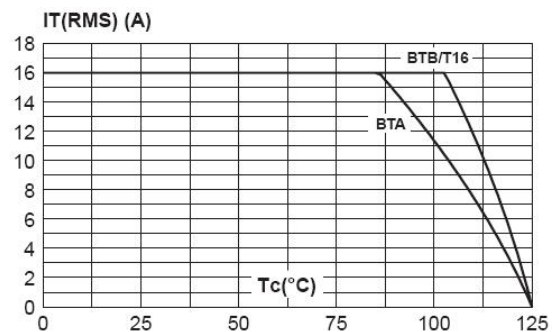
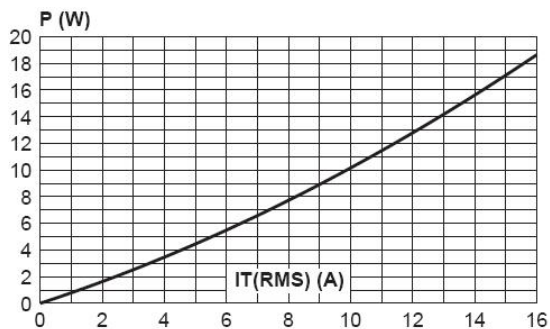

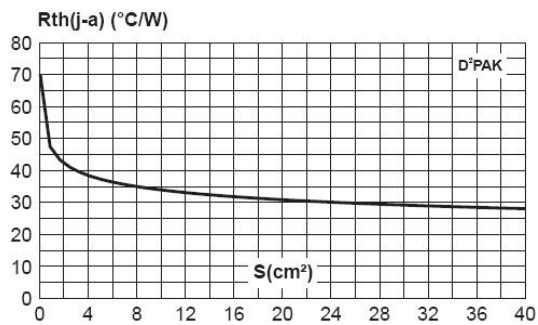
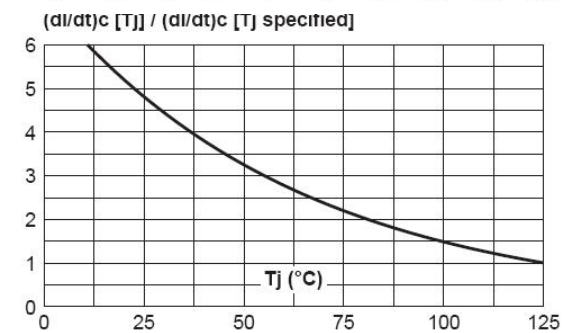
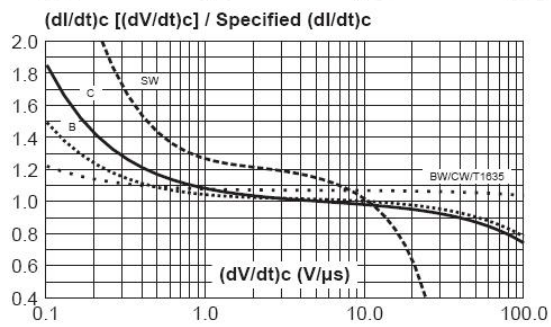
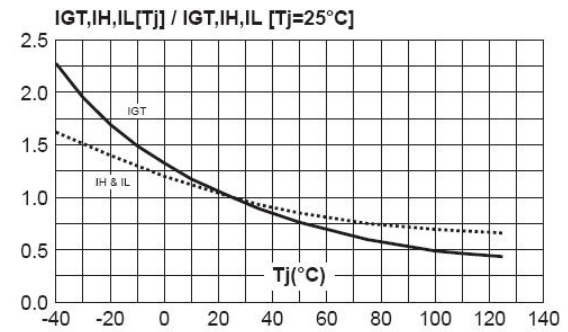
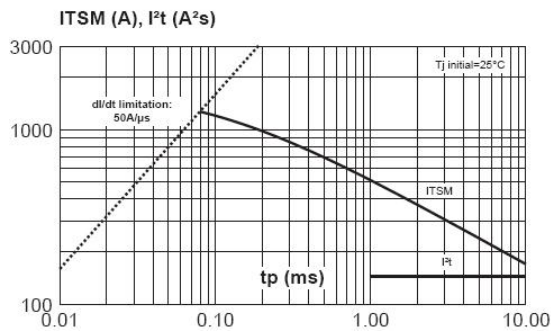
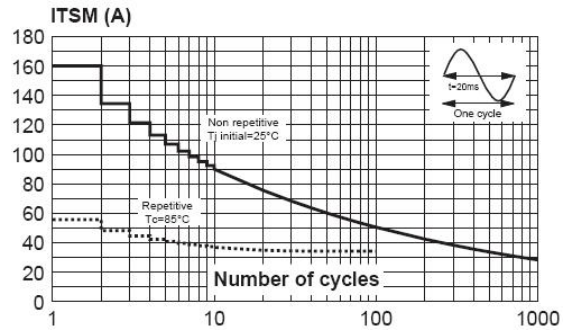
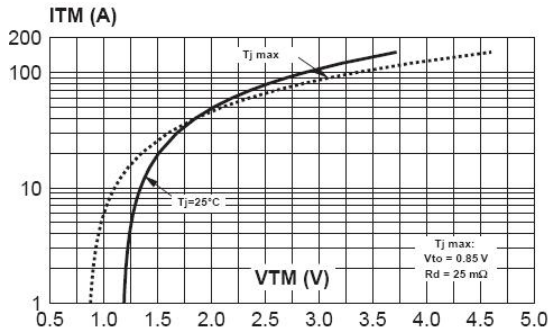
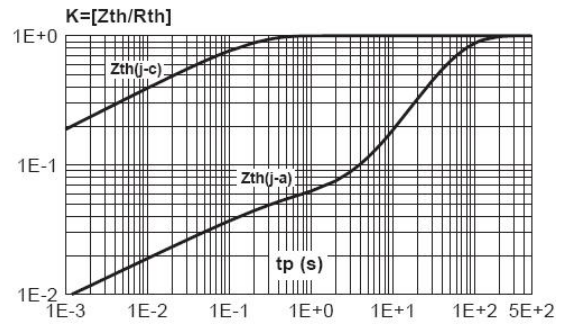
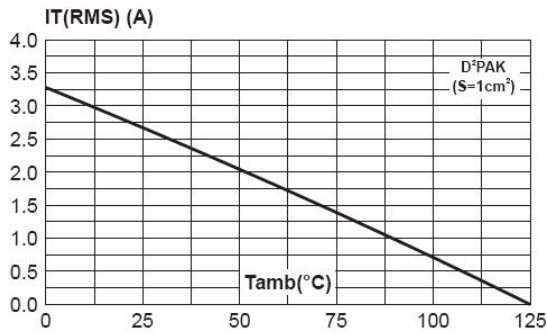

◆ 产品尺寸

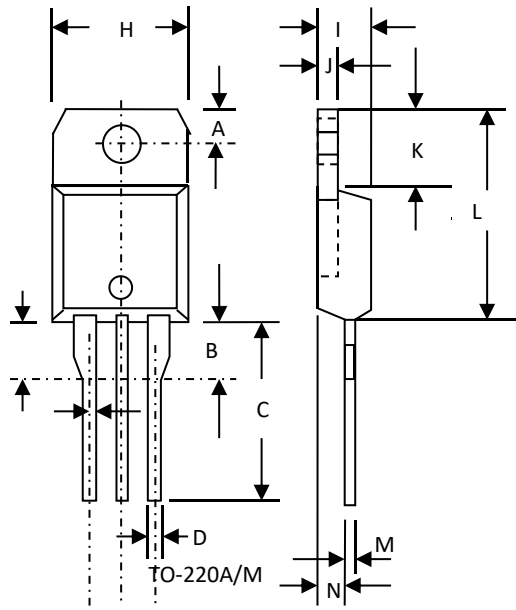

REF.	DIMENSIONS	
	Millimeters	Inches
	Type	Type
A	3.03	0.119
B	3.6	0.142
C	14.33	0.564
D	0.83	0.033
H	10.02	0.394
I	4.45	0.174
J	1.28	0.05
K	6.56	0.258
L	15.41	0.605
M	0.48	0.019
N	2.72	0.106

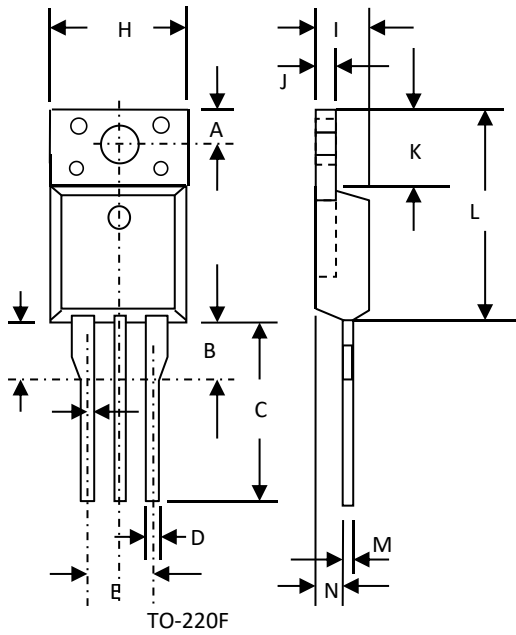

REF.	DIMENSIONS		REF.	DIMENSIONS	
	Millimeters	Type		Millimeters	Type
	A	3.35±0.03			I
B	3.3±0.03		J	2.63±0.02	
C	12.77±0.03		K	6.8±0.01	
D	0.8±0.01		L	15.7±0.03	
E	5.06±0.02		M	0.5±0.01	
H	10.12±0.03		N	2.4±0.02	

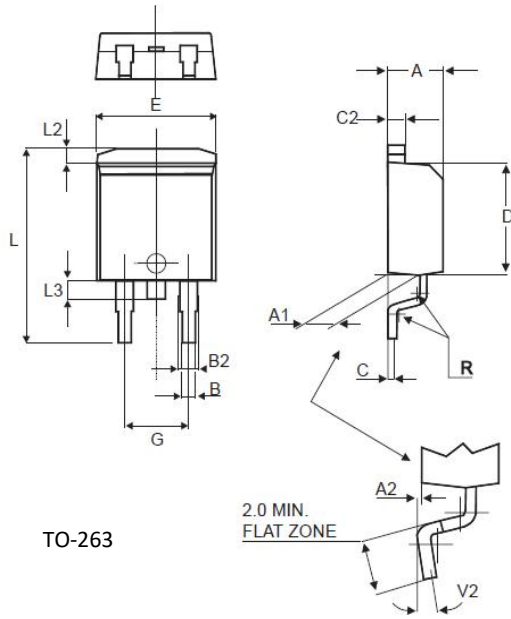

REF.	DIMENSIONS					
	Millimeters			Inches		
	Min.	Typ.	Max.	Min.	Typ.	Max.
A	4.30		4.60	0.169		0.181
A1	2.49		2.69	0.098		0.106
A2	0.03		0.23	0.001		0.009
B	0.70		0.93	0.027		0.037
B2	1.25	1.40		0.048	0.055	
C	0.45		0.60	0.017		0.024
C2	1.21		1.36	0.047		0.054
D	8.95		9.35	0.352		0.368
E	10.00		10.28	0.393		0.405
G	4.88		5.28	0.192		0.208
L	15.00		15.85	0.590		0.624
L2	1.27		1.40	0.050		0.055
L3	1.40		1.75	0.055		0.069
R		0.40			0.016	
V2	0°		8°	0°		8°